

Varenummer: 2310431046S
Beskrivelse: E+G Stilleben
LX.40-SW17-M10X72-S

Mål

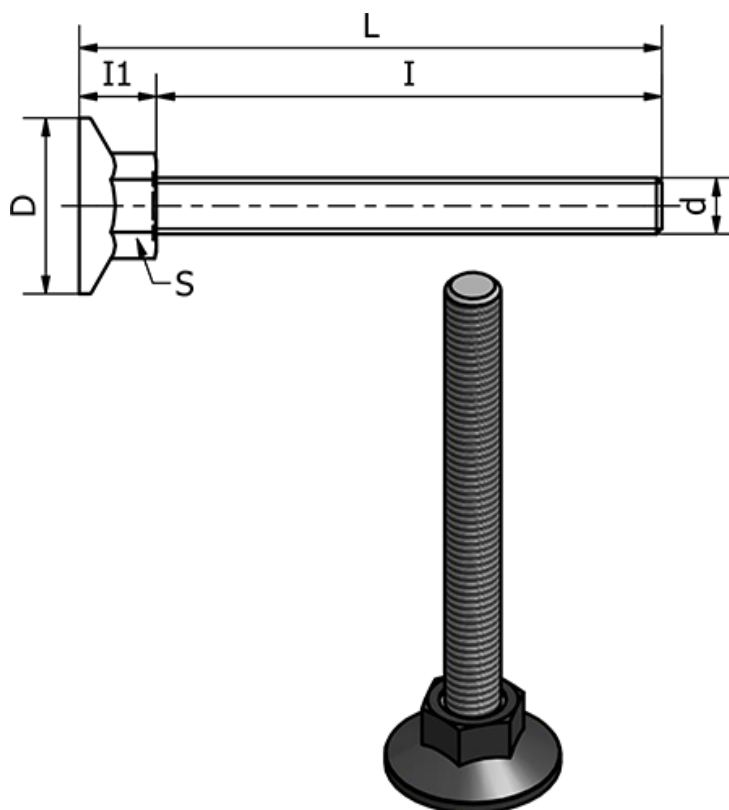

d	= M10
D	= 40
I	= 72
I1	= 13
L	= 84.5
Max statisk belastning (N)	= 3000
S	= 17
Type	= Forzinket

Vægt (g) = -